



Quality at its best  
MADE IN AUSTRIA



# Garden Shed Neo





Neo Size 2B, Metallic Quartz Grey  
(with SmartBase foundation, acrylic glass panel and double door as accessories)

# Neo

## REVOLUTION IN DESIGN & FUNCTIONALITY

### The Best From Decades of Experience

Smooth wall surfaces and the elegant acrylic glass panel in the door characterise the modern look. Additional acrylic glass panels can be flexibly installed thanks to a specially developed panel system. To ensure a pleasant atmosphere, the wooden ceiling regulates the humidity along with the optional grey white interior panelling and insulation.

### ADVANTAGES

#### Security:

- 3-way locking mechanism complete with stainless steel door handle
- Stable roof construction for a snow load of up to 150 kg/m<sup>2</sup>
- Storm proof up to 150 km/h, wind force 12

#### Functionality:

- Comfortable door opening with gas spring
- Direct attachment of the accessories
- Optional interior panelling and insulation
- Integrated roof gutter

### COLOURS

Available in one or two colours (a second colour can be chosen for the door and roof at no extra cost).



Metallic Silver

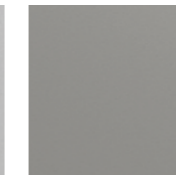

Metallic Quartz Grey



Metallic Dark Grey

### COLOUR COMBINATIONS

NO EXTRA COST



**Variant: 3.1**  
**Wall Colour:** Metallic Dark Grey  
**Roof and Door Colour:** Metallic Silver



**Variant: 2.3**  
**Wall Colour:** Metallic Quartz Grey  
**Roof and Door Colour:** Metallic Dark Grey

### SIZES (IN CM, OUTER DIMENSIONS INCL. ROOF OVERHANG)

**Door Opening:** Standard Door (right door hinge): 78 x 200 cm (W x H) - the standard door can be installed on the sides of the shed.  
Double Door: 161 x 200 cm (W x H) - the double door can be installed on the 235 cm sides of the shed.

The dotted lines mark the roof overhang.

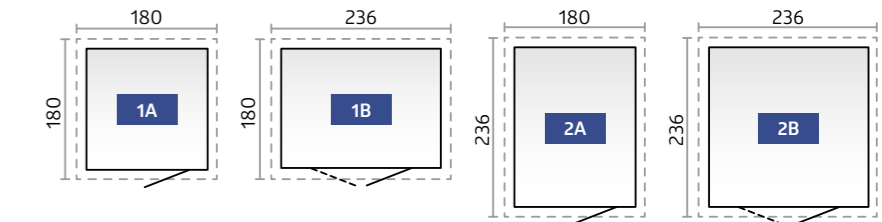

### STANDARD EQUIPMENT AND SPECIAL FEATURES

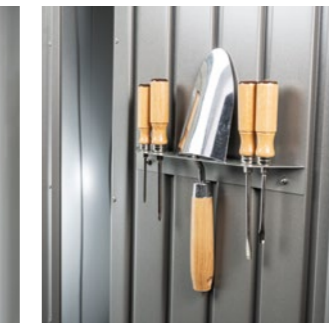
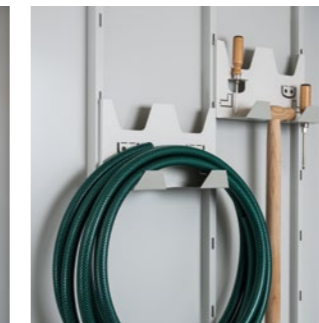
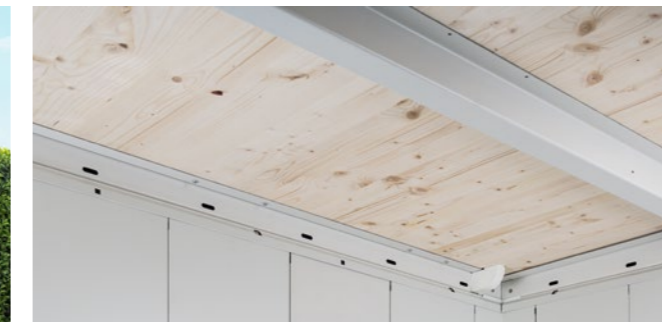

#### Standard Equipment and Special Features

Smooth side walls and an acrylic glass panel in the standard door make the Biohort Garden Shed Neo a real eye-catcher. The wooden ceiling visible on the inside regulates the air humidity thanks to its hygroscopic properties. On the outside, the wooden roof is efficiently protected by a full-surface, high-quality EPDM roofing membrane (thickness: 1.5 mm). The accessories can be mounted directly onto the wall. The following accessories are included in the delivery (2 pieces each): rainwater downpipes, shelves (depth: 25 cm), tool holder, tool hangers.

### OPTIONAL ACCESSORIES



Without Interior Panelling ← → With Interior Panelling

#### Many Options for the Interior Fittings

The garden shed Neo is not only optically highly versatile, with the right accessories it is also widely adaptable. Thanks to the flexible panel system, additional acrylic glass panels can be installed individually (not side by side). An elegant interior panelling is available for the interior walls (pictured right). This can even be insulated with 40mm styrofoam (accessory). You will find more practical accessories on the next page.

# TECHNICAL DATA

\*\* highest point, incl. roof overhang

EAN Code



Size	Exterior Dimensions**	Interior Dimensions	Foundation Dimensions	Weight (kg)	Metallic Silver	Metallic Quartz Grey	Metallic Dark Grey	Wall Colour	EAN Code					
	W x L x H (cm)	W x L x H (cm)	W x L (cm)						Variant: 1.2	Variant: 1.3	Variant: 2.1	Variant: 2.3	Variant: 3.1	Variant: 3.2
With Standard Door, Door Opening: 78 x 200 cm (B x H), right door hinge														
1A	180 x 180 x 222	164 x 164 x 208	171 x 171	170	9003414 81003 7	9003414 87003 1	9003414 85003 3		9003414 81005 1	9003414 81004 4	9003414 87004 8	9003414 87005 5	9003414 85004 0	9003414 85005 7
1B	236 x 180 x 222	220 x 164 x 208	227 x 171	205	9003414 81029 7	9003414 87029 1	9003414 85029 3		9003414 81033 4	9003414 81030 3	9003414 87030 7	9003414 87033 8	9003414 85030 9	9003414 85033 0
2A	180 x 236 x 222	164 x 220 x 208	171 x 227	205	9003414 81006 8	9003414 87006 2	9003414 85006 4		9003414 81008 2	9003414 81007 5	9003414 87007 9	9003414 87008 6	9003414 85007 1	9003414 85008 8
2B	236 x 236 x 222	220 x 220 x 208	227 x 227	230	9003414 81034 1	9003414 87034 5	9003414 85034 7		9003414 81039 6	9003414 81037 2	9003414 87037 6	9003414 87039 0	9003414 85037 8	9003414 85039 2
With Double Door, Door Opening: 161 x 200 cm (W x H)														
1B	236 x 180 x 222	164 x 220 x 208	227 x 171	215	9003414 81060 0	9003414 87060 4	9003414 85060 6		9003414 81062 4	9003414 81061 7	9003414 87061 1	9003414 87062 8	9003414 85061 3	9003414 85062 0
2B	236 x 236 x 222	220 x 220 x 208	227 x 227	240	9003414 81063 1	9003414 87063 5	9003414 85063 7		9003414 81067 9	9003414 81064 8	9003414 87064 2	9003414 87067 3	9003414 85064 4	9003414 85067 5

Foundation Accessories / Interior Fittings	EAN Code	EAN Code	EAN Code	EAN Code	EAN Code	EAN Code
suitable for	<b>Aluminium Floor Frame</b>	<b>Aluminium Floor Panels</b>	<b>SmartBase</b>	<b>SmartBase<sup>PLUS</sup></b>	<b>Interior Panelling</b>	<b>Insulation</b>
<b>Neo</b>						
1A	9003414 41014 5	9003414 48014 8	9003414 43950 4	9003414 43450 9	9003414 46051 5	9003414 46081 2
1B / 2A	9003414 41024 4	9003414 48024 7	9003414 43954 2	9003414 43454 7	9003414 46052 2	9003414 46082 9
2B	9003414 41040 4	9003414 48040 7	9003414 43918 4	9003414 43418 9	9003414 46054 6	9003414 46084 3
1B (Double Door)	9003414 41024 4	9003414 48024 7	9003414 43954 2	9003414 43454 7	9003414 46053 9	9003414 46081 2
2B (Double Door)	9003414 41040 4	9003414 48040 7	9003414 43918 4	9003414 43418 9	9003414 46055 3	9003414 46082 9

Note: Hammer drills can be rented from any well-equipped specialist, however the drill bit required is available from Biohort.

Drill Bit Ø 40 x 600 mm for SDS-MAX chuck Ø 18 mm (for SmartBasePLUS) 9003414 43410 3

Note: In combination with an additional door, an additional package is required for the SmartBase and SmartBase<sup>PLUS</sup>.

Foundation Additional Package 9003414 43505 6 9003414 43405 9

Accessories	Dimensions W x L x H (cm)	EAN Code		
		Metallic Silver	Metallic Quartz Grey	Metallic Dark Grey
In the respective colour				
Acrylic Glass Panel	32 x 3,3 x 207	9003414 47034 7	9003414 47084 2	9003414 47054 5
Additional Door	203 x 83 x 3	9003414 81002 0	9003414 87002 4	9003414 85002 6
Tool Holder	30 x 5 x 3,5	9003414 47032 3	9003414 47082 8	9003414 47052 1
Accessories made of galvanised steel, grey white coated				
Shelves	2 pieces per package	56 x 26 x 17,3	9003414 45040 0	
	4 pieces per package	56 x 26 x 17,3	9003414 45050 9	
	2 pieces per package (deep)	56 x 44,5 x 17,3	9003414 45060 8	
Suspension Basket	With wall bracket	56 x 34 x 20	9003414 47073 6	
Hook Set	Combination of hook, handle hook and shovel hook	56 x 23 x 10	9003414 47072 9	
Tool Hangers	2 pieces per package	28 x 10,4 x 17,2	9003414 47021 7	
Threshold Access Ramp	Only with double door and floor frame	70,5 x 9,1 x 3	9003414 41001 5	
Bicycle Hanger "BikeMax"	1 piece per package	205,5 x 14,5 x 8	9003414 49030 7	
Bicycle Holder "BikeHolder"	Set for 2 bikes	56 x 17,7 x 33	9003414 49032 1	
Electric Mounting Panel		28 x 204 x 4	9003414 46034 8	
LED Light		44 x 4 x 1,5	9003414 46041 6	



**Biohort GmbH**  
 Pürnstern 43, 4120 Neufelden, Austria  
 Tel: +43-7282-7788-0, Fax Ext. 190  
 E-Mail: office@biohort.at, www.biohort.com

Technical modifications, misprints and colour deviations reserved.



QUALITY FROM **AUSTRIA**



# STÜCKLISTE **Gerätehaus „NEO“**

Stand Dezember 2020 | technische Änderungen vorbehalten



[www.biohort.com](http://www.biohort.com)

## 1 TÜRPAKET

Doorpackage · Carton de portes · Deurpakket · Kit de puerta · Pacco porta · Dørpakke

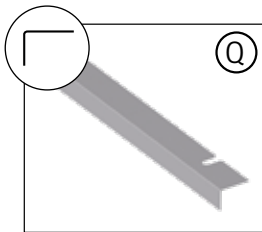
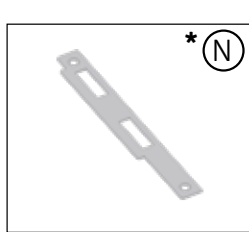
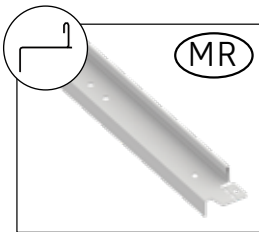
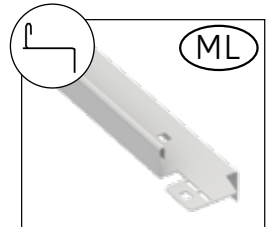
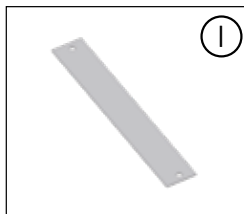
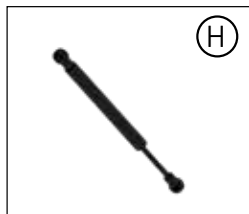
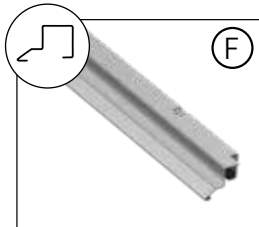
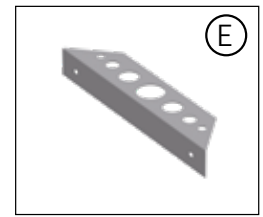
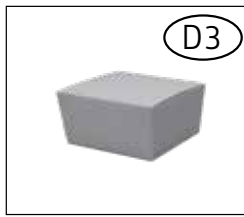
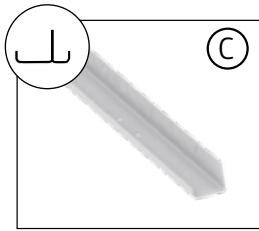
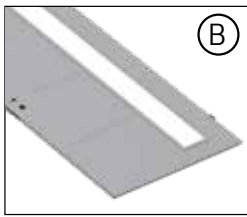

### ZUSATZTEILE DOPPELTÜR

double door package | carton de double portes |  
dubbeldeurpakket | pacco porta doppia |  
kit de puerta adicional | Ekstradele dobbeltdør

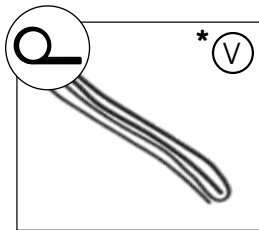
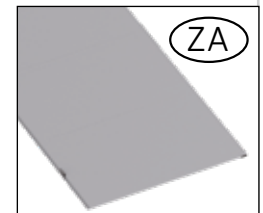

### \* TEIL ENTFÄLLT BEI DER DOPPELTÜR

- (GB) Part not required when double doors are fitted
- (FR) La pièce est supprimée pour la double portes.
- (NL) Deel vervalt bij de dubbele deur
- (ES) Pieza no es necesaria en caso de puerta doble
- (IT) Pezzo non può essere utilizzato per la variante porta a due battenti
- (DK) Del ikke nødvendig med dobbeltdør

## 2 SEITEN-PANEELPAKET

Side panel package · Carton de parois latérales · Zijwandpakket · Panel la teral · Pacco pareti laterali · Sidepladepakke

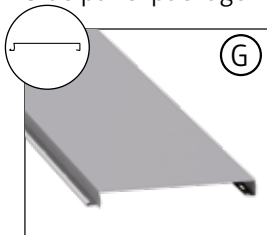

## 3 PROFILPAKET TIEFE

Profile package depth · Colis profond des profilés · Diepte Profielpakket · Profundidad del paquete de perfiles · Profondità del pacchetto di profili · Profilpakke dybde

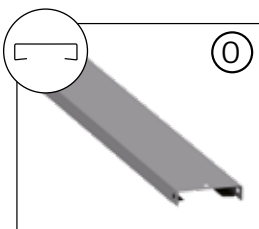
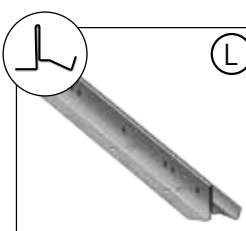
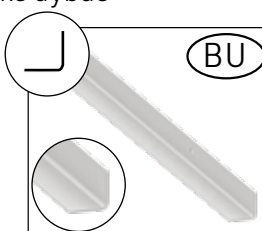
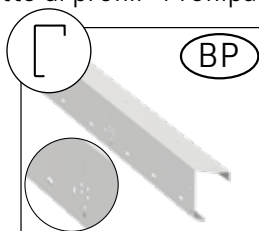
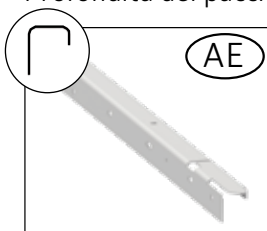

## 3a PROFILPAKET BREITE

Profile package width · Colis large des profilés · Breedte profielpakket · Ancho del paquete de perfiles · Larghezza del pacchetto di profili · Profilpakke bredde

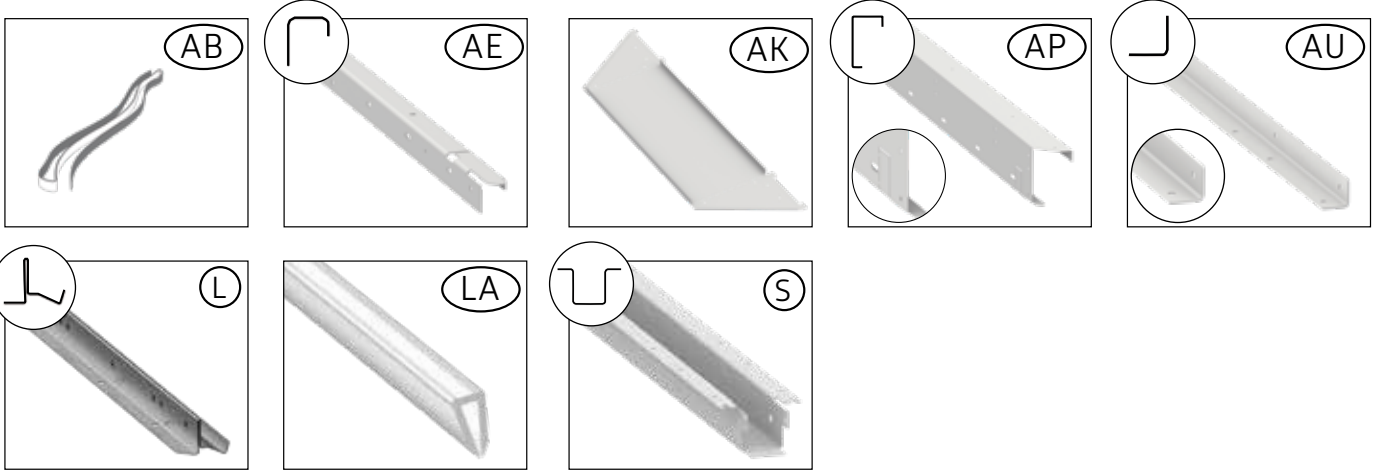

## 4 DACH - HOLZPAKET

Roof wooden package · Colis du toit en bois · Houten dakbedekking pakket · Paquete para el techo - Madera · Pacchetto di legno per tetti · Tagpakke træ



## 5 DACH - PROFILPAKET

Top profile package · Carton de profils de toit · Dakprofielpakket · Kit de perfiles de tejado · Pacco profili del tetto · Tagprofilpakke

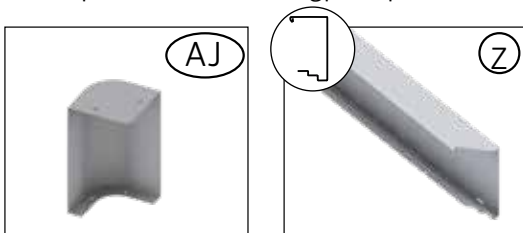

## 6 DACH - FOLIENPAKET

Roof foil package · Colis du film EPDM du toit · Dakfolie pakket · Paquete-Película para el techo · Pacchetto di telo per tetto · Tagpakke folie



## 7 ECKPANEELPAKET

Corner panel package · Colis des parois d'angle · Hoekpaneel pakket · Paquete de paneles de esquina · Pacchetto pannello angolare · Hjørnepanel pakke

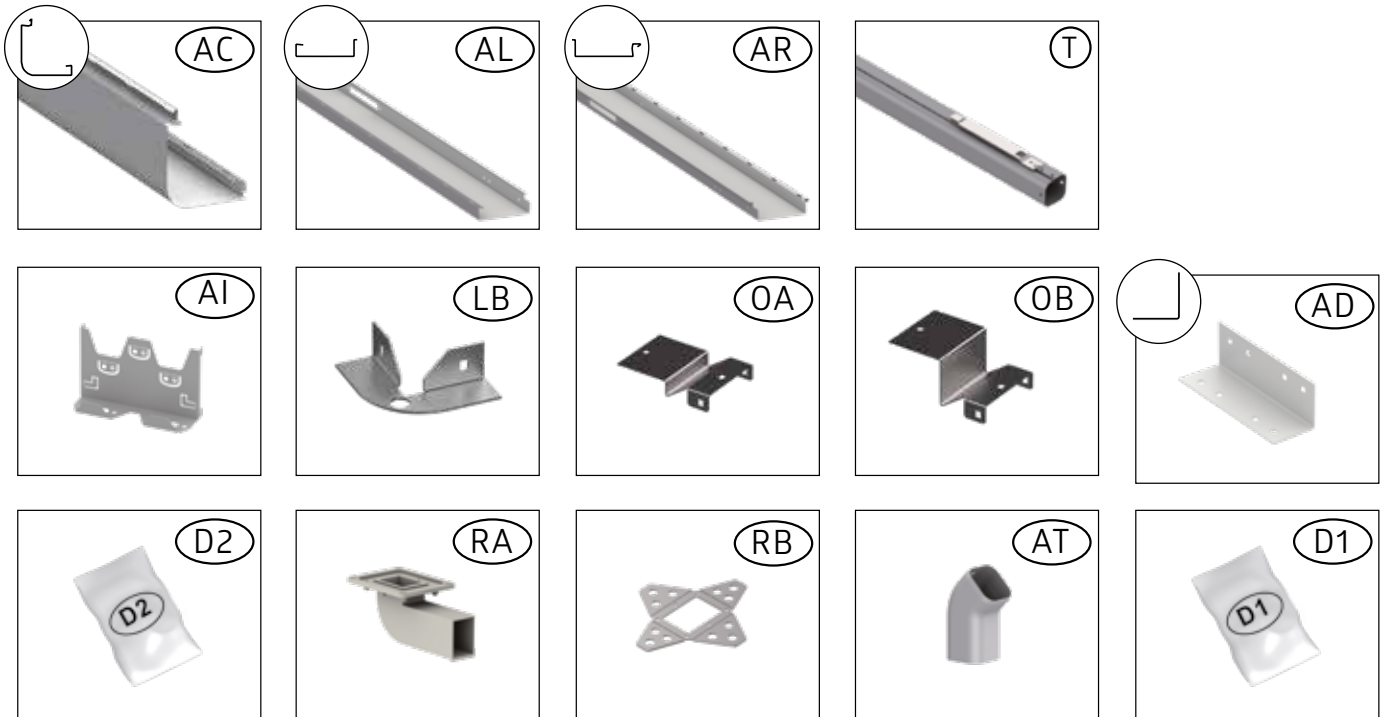

## BODENRAHMEN

Floor Frame · Cadre de sol · Bodemframe · Marco de suelo · Telaio perimetrale · Bundramme

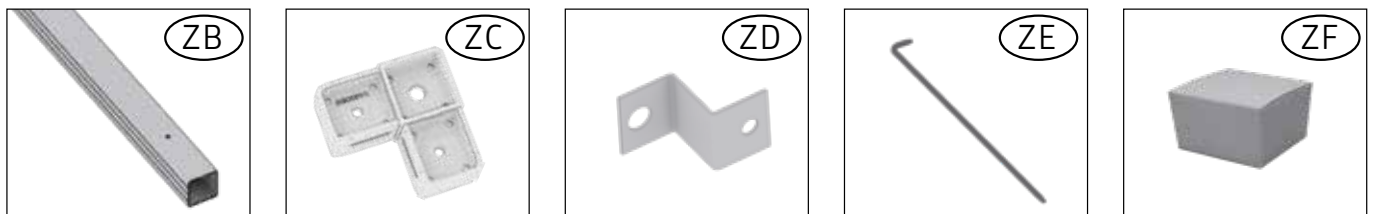

## LICHTPANEEL

Acrylic glass panel · Panneau lumineux · Lichtpaneel · Panel de luz · Elemento in vetro acrilico · Akrylglas panel

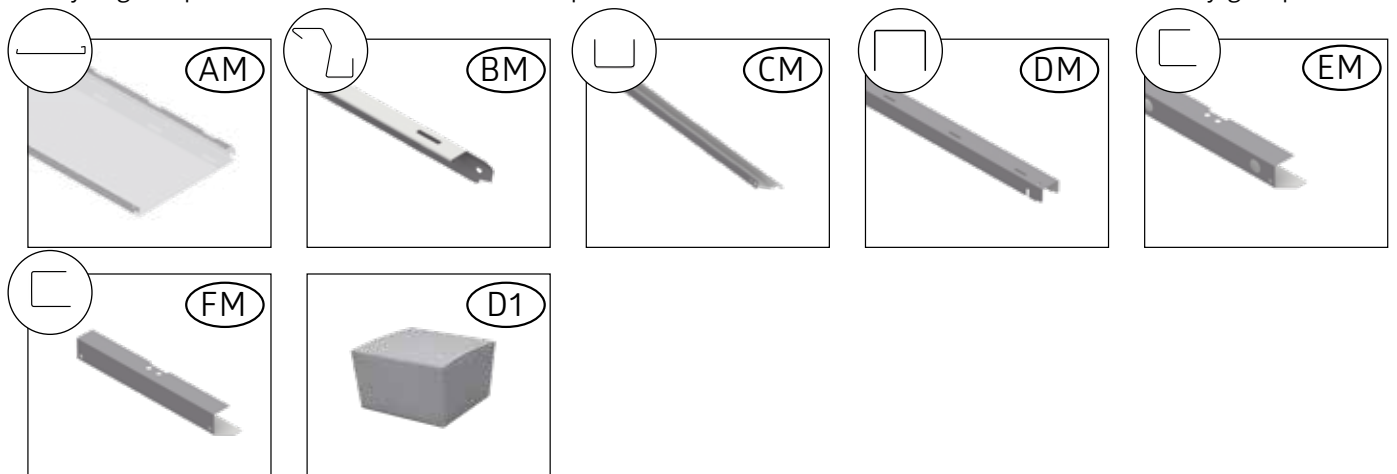

					1A	1B	2A	2B
Paket Nr.	Pos.-Nr.	Artikel-Nummer	Maße (mm)	Artikelname	Stk.	Stk.	Stk.	Stk.
 <p><b>Paket Nr. 1</b> Standardtürpaket 81011 85011 87011</p>	<b>B</b>	EN*00220	/	Tür rechts komplett	1	1	1	1
	<b>C</b>	XN601116	779	Versteifung Kopfprofil	1	1	1	1
	<b>E</b>	XN*00430	/	Werkzeughalter Glastür	2	2	2	2
	<b>F</b>	XN701106	835	Türbodenschwelle Standardtür	1	1	1	1
	<b>ML</b>	XN600111	/	Türanschlagprofil links	1	1	1	1
	<b>MR</b>	XN600110	/	Türanschlagprofil rechts	1	1	1	1
	<b>Q</b>	XN*01109	880	Abdeckleiste Kopfprofil Standardtür	1	1	1	1
	<b>V</b>	XN702134	2000	Gummiprofil	1	1	1	1
		XH780011	/	Kleinteilepaket für Standardtür	1	1	1	1
	<b>D3</b>	XH700241	/	Türdrückergarnitur	1	1	1	1
	<b>D4</b>	XH700547	/	Kleinteilepäckchen für Standardtür	1	1	1	1
	<b>H</b>	X3000224	/	Gasdruckfeder 75N	1	1	1	1
	<b>I</b>	XH700248	/	Abdeckblech f. Türanschlagprofil	1	1	1	1
	<b>J</b>	X3000227	/	Gasfederkonsole für Tür	1	1	1	1
	<b>N</b>	XH700246	/	Schließblech für Tür rechts	1	1	1	1
-	XH700245	/	Profilzylinder mit Schlüssel	1	1	1	1	

					1A	1B	2A	2B
 <p><b>Paket Nr. 1</b> Doppeltürpaket 81021 85021 87021</p>	<b>B</b>	EN*00220	/	Tür rechts komplett	-	1	-	1
	<b>C</b>	XN602116	1619	Versteifung Kopfprofil	-	1	-	1
	<b>E</b>	XN*00430	/	Werkzeughalter Glastür	-	2	-	2
	<b>F</b>	XN702106	1675	Türbodenschwelle Doppeltür	-	1	-	1
	<b>ML</b>	XN600111	/	Türanschlagprofil links	-	1	-	1
	<b>MR</b>	XN600110	/	Türanschlagprofil rechts	-	1	-	1
	<b>Q</b>	XN*02109	1720	Abdeckleiste Kopfprofil Doppeltür	-	1	-	1
	<b>ZA</b>	EN*00240	/	Tür links komplett	-	1	-	1
		XH780021	/	Kleinteilepaket für Doppeltür	-	1	-	1
	<b>D3</b>	XH700241	/	Türdrückergarnitur	-	1	-	1
	<b>D4</b>	XH700548	/	Kleinteilepäckchen für Doppeltür	-	1	-	1
	<b>H</b>	X3000224	/	Gasdruckfeder 75N	-	2	-	2
	<b>I</b>	XH700248	/	Abdeckblech für Türanschlagprofil	-	2	-	2
	<b>J</b>	X3000227	/	Gasfederkonsole für Tür	-	2	-	2
	<b>K</b>	XH700250	/	Drehknopf innen mit Rosette	-	1	-	1
-	XH700245	/	Profilzylinder mit Schlüssel	-	1	-	1	

					1A	1B	1B	2A	2B	2B
					(ST)	(ST)	(DT)	(ST)	(ST)	(DT)
 <p><b>Paket Nr.2</b> Seiten-Paneelpaket 8#022 8#032 8#052</p>	<b>G</b>	XN*00100	/	Seitenwandpaneel	16	20	17	20	24	21



					1A	1B	2A	2B
 <p><b>Paket Nr. 3</b>            Profilpaket Tiefe            80013 (1A/1B)            80023 (2A/2B)</p>	AE	XN601107	1661	Kopfprofil	2	2		
		XN602107	2221				2	2
	L	XN701104	1631	Bodenprofil	2	2		
		XN702104	2191				2	2
	LA	XN701110	1631	Kunststoffabdeckprofil	2	2		
		XN702110	2191				2	2
	O	XN801309	1573	Befestigungsstrebe Dachfolie	2	2		
		XN802309	2133				2	2
	BP	XN601325	1717	Dachauflage	2	2		
		XN602325	2277				2	2
BU	XN601326	1553	Holzauflegewinkel	2	2			
	XN602326	2113				2	2	

					1A	1B	2A	2B
 <p><b>Paket Nr. 3a</b>            Profilpaket Breite            80113 (1A/2A)            80123 (1B/2B)</p>	AE	XN601107	1661	Kopfprofil	2		2	
		XN602107	2221			2		2
	AK	XI604402	/	Regalboden	2	2	2	2
		L	XN701104		1631	Bodenprofil	2	
	XN702104		2191		2			2
	LA	XN701110	1631	Kunststoffabdeckprofil	2		2	
		XN702110	2191			2		2
	AP	XN601324	1717	Dachauflage	2		2	
		XN602324	2277			2		2
	S	XN601328	1690	Dachträger	2		2	
		XN602328	2250			2		2
	AU	XN601327	1619	Holzauflegewinkel	2		2	
XN602327		2179			2		2	
AB	X4000451	3300	Moosgummi (4 Stk. a´ 3300x9x2)	1	1	1	1	

					1A	1B	2A	2B
 <p><b>Paket Nr. 4</b>            Dach-Holzpaket            80014 (1A)            80024 (1B)            80054 (2A)            80064 (2B)</p>	W	XN701301	/	Holzplatte 3-Schicht links	1	1		
		XN702301					1	1
	X	XN701300	/	Holzplatte 3-Schicht mitte	2	3		
		XN702300					2	3
	Y	XN701302	/	Holzplatte 3-Schicht rechts	1	1		
		XN702302					1	1

					1A	1B	2A	2B
 <p><b>Paket Nr. 5</b>            Dach-Profilpaket            8#015            8#025</p>	AJ	XN*00311	/	Eckabdeckung Dacheinfassung	4	4	4	4
	Z	XN*01308	1737	Dacheinfassung	4	2	2	
		XN*02308	2297			2	2	4

					1A	1B	2A	2B
 <p><b>Paket Nr. 6</b>            Dach-Folienpaket            80016            80026            80036</p>	R	XN001300	/	Dachfolie Gr. 1A	1			
		XN002300	/	Dachfolie Gr. 1B/2A		1	1	
		XN002310	/	Dachfolie Gr. 2B				1



					1A	1B	2A	2B
<b>Paket Nr. 7</b> Eckpaneelpaket 81099 85099 87099	<b>AC</b>	XN*00102	/	Eckpaneel	4	4	4	4
	<b>AL</b>	XN*00105	/	Vorderwandelement links	1	1	1	1
	<b>AR</b>	XN*00104	/	Vorderwandelement rechts	1	1	1	1
	<b>D1</b>	XN700550	/	Kleinteilepäckchen	1	1	1	1
	<b>T</b>	EN*00410	/	Regenfallrohr komplett	2	2	2	2
	<b>AT</b>	X4*00422	/	Auslaufbogen Regenfallrohr	2	2	2	2
	<b>D2</b>	XN700580		Kleinteilepaket	1	1	1	1
	<b>AD</b>	XN600321	/	Knotenblech Kopfprofil	4	4	4	4
	<b>AI</b>	XI604425	/	Gerätehalter	2	2	2	2
	<b>LB</b>	XN700322	/	Eckverbinder Bodenprofil	4	4	4	4
	<b>RA</b>	XN600427	/	Dachgully	2	2	2	2
	<b>RB</b>	XN700426	/	Laubfang Dachgully	2	2	2	2
	<b>OA</b>	XN700430	/	Befestigung Dachstrebe hinten	2	2	2	2
	<b>OB</b>	XN700431	/	Befestigung Dachstrebe vorne	2	2	2	2

Farbe	Auswahl Artikelnummer (gilt nicht für Verkaufartikelnummer)	
silber-metallic	* ..... → <b>3</b> .....	# .... → <b>1</b> ....
dunkelgrau-metallic	* ..... → <b>4</b> .....	# .... → <b>5</b> ....
quarzgrau-metallic	* ..... → <b>8</b> .....	# .... → <b>7</b> ....

					1A	1B	2A	2B
<b>Bodenrahmen</b> 41014 (1A) 41024 (1B/2A) 41040 (2B)	<b>ZB</b>	XN000617	1580	Alu-Formrohr	4	2	2	
		X0001603	2140			2	2	4
	<b>ZC</b>	X4000610	/	Eckverbindung-Bodenrahmen	4	4	4	4
	<b>ZD</b>	X4000611	/	Bodenbefestigungswinkel	4	4	4	4
	<b>ZE</b>	X4000612	/	Bodenanker	8	8	8	8
	<b>ZF</b>	X4000560	/	Schraubenpaket f. Bodenrahmen	1	1	1	1

				1A	1B	2A	2B
Paket-Nr.	Artikel-Nummer	Artikelname		Stk.	Stk.	Stk.	Stk.
<b>ZF</b> <b>Schraubenpaket</b> X4000560	X4000611	Bodenbefestigungswinkel		4	4	4	4
	A51043	Sechskant Blechschraube 6,3x22		12	12	12	12
	A2000028	Beilagscheibe 6,4x12x1,6		12	12	12	12
	A4005010	Beilagscheibe 6,6x22x2		12	12	12	12

					1A	1B	2A	2B
<b>Lichtpaneel</b> 470#4	<b>AM</b>	XI700434		Lichtpaneel	1	1	1	1
	<b>BM</b>	XI*00435		Rahmenprofil links	1	1	1	1
	<b>CM</b>	XI*00436		Rahmenprofil rechts	1	1	1	1
	<b>DM</b>	XI*00432		Rahmenprofil oben	1	1	1	1
	<b>EM</b>	XI*00433		Rahmenprofil unten	1	1	1	1
	<b>FM</b>	XI*00437		Abdeckleiste	2	2	2	2
	<b>GM</b>	XI700456		Schraubenpaket Lichtpaneel	1	1	1	1

				1A	1B	2A	2B
Paket-Nr.	Artikel-Nummer	Artikelname		Stk.	Stk.	Stk.	Stk.
<b>GM</b> <b>Schraubenpaket</b> XI700456	A52002	Flachrundschraube M5x10		7	7	7	7
	A2000033	Mutter M5		7	7	7	7
	A4001005	Schnappmutter		7	7	7	7
	A4002019	Sechskant Blechschraube 4,8x19		8	8	8	8
	A2000025	Beilagscheibe		15	15	15	15

1A, 1B, 2A, 2B			
Paket Nr.	Artikel-Nummer	Artikelname	Stk.
 <p><b>D1</b> Kleinteilepäckchen XN700550</p>	X2000065	Steckschlüssel SW8 mit blauen Griff	1
	X2000064	Gabeschlüssel SW8	1
	A52012	Drahtstift 5x140mm	1
	A52076	Sechskant Holzschraube 8x60mm	12
	A55007	Beilagscheibe	12
	A51050	Dübel schwarz	12
	X3000419	Abdeckkappen	50
	Y1000006	Schlüsselanhänger	1
	X2000040	Handschuhe	1
	XI700403	Sicherungsteil Regalboden u. Wandschiene	4
	ZW020010	Kapselheber	1
	X2000070	Torx-Biteinsatz TX25	1
	XN700551	Schraubenpaket	1
	A52002	Flachrundschraube M5x10	122
	A52004	Flachrundschraube M5x18	20
	A2000033	Mutter M5	152
	A2000025	Beilagscheibe M5	240
	A4002019	Sechskant Blechschraube 4,8x19	110
	A4005006	Nirodichtscheibe	32
	A4002011	Niroblechschraube Kreuzschlitz 3,9x13	10
A4001005	Schnappmutter vz	72	
A4003019	Halbrundkopfschraube 5x20, TX25	55	
A2000035	Käfigmutter M5	14	
A51017	Sechskantschraube M5x16	14	

1A, 1B, 2A, 2B			
Paket Nr.	Artikel-Nummer	Artikelname	Stk.
 <p><b>D2</b> Kleinteilepaket XN700580 XN700581</p>	XN700428	Dichtung Dachgully	2
	A4002004	Niroblechschraube 4,8x13	20
	A4003020	Senkblechschrauben 4,8x13	10
	XB706209	Gummipuffer mit Zapfen	2

Standardtür / Doppeltür			
Paket Nr.	Artikel-Nummer	Artikelname	Stk.
<b>D3</b> Türdrücker	XH700241	Türdrückergarnitur	1

Paket Nr.	Artikel-Nummer	Artikelname	Standard-	Doppeltür
			tür	Stk.
 <p><b>D4</b> Kleinteilepäckchen Standardtür/ Doppeltür XH700547 XH700548</p>	A4003026	Senkschraube mit Kreuzschlitz M5x12	2	-
	A52002	Flachrundschraube M5x10	20	22
	A2000033	Mutter M5	22	22
	A2000025	Beilagscheibe	28	36
	A4002017	Sechskant Blechschraube	6	14
	X3000203	Edelstahlscharnier "A" männlich	1	2
	X3000204	Edelstahlscharnier "B" männlich	1	2
	X2700225	Kugelbolzen M8	1	2
	A4001007	Federring	1	2
	A54009	Sechskantmutter M8	1	2

					1A	1B	2A	2B
Paket Nr.	Pos.-Nr.	Artikel-Nummer	Maße (mm)	Artikelname	Stk.	Stk.	Stk.	Stk.
 <p><b>Paket Nr. 1</b> Standardtürpaket 81011 85011 87011</p>	<b>B</b>	EN*00220	/	Tür rechts komplett	1	1	1	1
	<b>C</b>	XN601116	779	Versteifung Kopfprofil	1	1	1	1
	<b>E</b>	XN*00430	/	Werkzeughalter Glastür	2	2	2	2
	<b>F</b>	XN701106	835	Türbodenschwelle Standardtür	1	1	1	1
	<b>ML</b>	XN600111	/	Türanschlagprofil links	1	1	1	1
	<b>MR</b>	XN600110	/	Türanschlagprofil rechts	1	1	1	1
	<b>Q</b>	XN*01109	880	Abdeckleiste Kopfprofil Standardtür	1	1	1	1
	<b>V</b>	XN702134	2000	Gummiprofil	1	1	1	1
		XH780011	/	Kleinteilepaket für Standardtür	1	1	1	1
	<b>D3</b>	XH700241	/	Türdrückergarnitur	1	1	1	1
	<b>D4</b>	XH700547	/	Kleinteilepäckchen für Standardtür	1	1	1	1
	<b>H</b>	X3000224	/	Gasdruckfeder 75N	1	1	1	1
	<b>I</b>	XH700248	/	Abdeckblech f. Türanschlagprofil	1	1	1	1
	<b>J</b>	X3000227	/	Gasfederkonsole für Tür	1	1	1	1
<b>N</b>	XH700246	/	Schließblech für Tür rechts	1	1	1	1	
-	XH700245	/	Profilzylinder mit Schlüssel	1	1	1	1	

					1A	1B	2A	2B
Paket Nr.	Pos.-Nr.	Artikel-Nummer	Maße (mm)	Artikelname	Stk.	Stk.	Stk.	Stk.
 <p><b>Paket Nr. 1</b> Doppeltürpaket 81021 85021 87021</p>	<b>B</b>	EN*00220	/	Tür rechts komplett	-	1	-	1
	<b>C</b>	XN602116	1619	Versteifung Kopfprofil	-	1	-	1
	<b>E</b>	XN*00430	/	Werkzeughalter Glastür	-	2	-	2
	<b>F</b>	XN702106	1675	Türbodenschwelle Doppeltür	-	1	-	1
	<b>ML</b>	XN600111	/	Türanschlagprofil links	-	1	-	1
	<b>MR</b>	XN600110	/	Türanschlagprofil rechts	-	1	-	1
	<b>Q</b>	XN*02109	1720	Abdeckleiste Kopfprofil Doppeltür	-	1	-	1
	<b>ZA</b>	EN*00240	/	Tür links komplett	-	1	-	1
		XH780021	/	Kleinteilepaket für Doppeltür	-	1	-	1
	<b>D3</b>	XH700241	/	Türdrückergarnitur	-	1	-	1
	<b>D4</b>	XH700548	/	Kleinteilepäckchen für Doppeltür	-	1	-	1
	<b>H</b>	X3000224	/	Gasdruckfeder 75N	-	2	-	2
	<b>I</b>	XH700248	/	Abdeckblech für Türanschlagprofil	-	2	-	2
	<b>J</b>	X3000227	/	Gasfederkonsole für Tür	-	2	-	2
<b>K</b>	XH700250	/	Drehknopf innen mit Rosette	-	1	-	1	
-	XH700245	/	Profilzylinder mit Schlüssel	-	1	-	1	

					1A	1B	1B	2A	2B	2B
					(ST)	(ST)	(DT)	(ST)	(ST)	(DT)
 <p><b>Paket Nr.2</b> Seiten-Paneelpaket 8#022 8#032 8#052</p>	<b>G</b>	XN*00100	/	Seitenwandpaneel	16	20	17	20	24	21

